

Carbon Dynamic Airbox

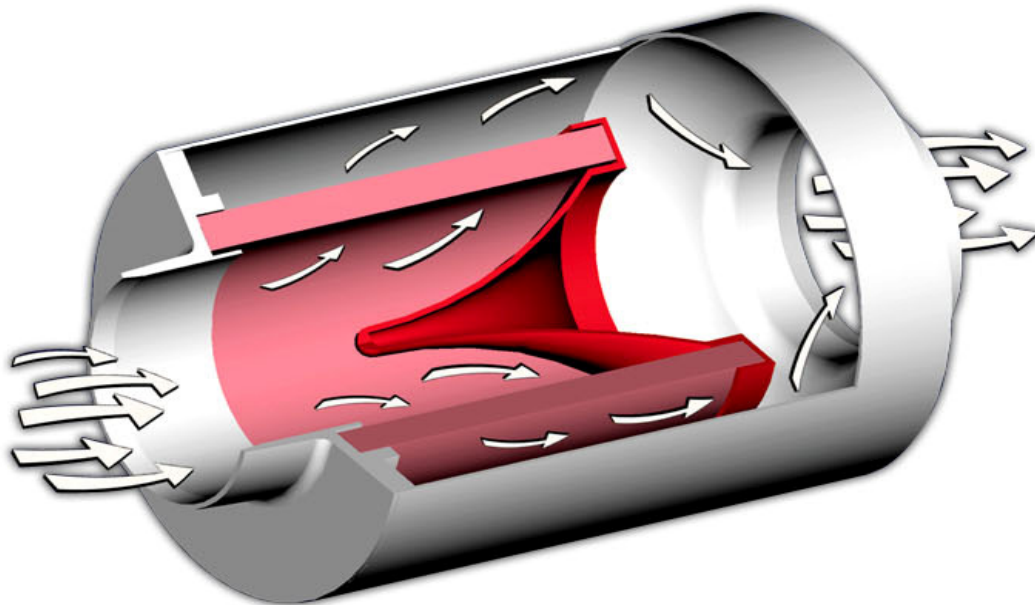

***Patented
Supercharging System***

Carbon Dynamic Airbox

De Carbon Dynamic Airbox van BMC is een compleet air intake systeem. Door de dynamic air intake creëert u een echte supercharging systeem (RAM-Air effect) dat koude lucht met een veel hogere snelheid en capaciteit naar de motor toevoert dan traditionele systemen.

De airflow die de Carbon Dynamic Airbox binnen gaat wordt verder versnelt door de conische flow variator binnenin de Carbon Dynamic Airbox. Uiteindelijk zal een aanzienlijke verhoging van het motorvermogen en trekkracht verzekerd zijn door elementen als dynamic overboosting, grotere airflow, hogere druk en koelere lucht. Daarom presteert deze technologie optimaal zowel naast als op het circuit.



Er is voor een standaard uitgevoerde auto veel vermogenswinst realiseerbaar, wij weten dat er over het algemeen een vermogenswinst realiseerbaar is van gemiddeld 5%. In de praktijk is dit ongeveer tussen de 2 en 25 pk (auto afhankelijk en getest op een geremde rollenbank). Wanneer u het management aanpast en/of een ander uitlaatsysteem plaatst, wordt het effect in combinatie met de Carbon Dynamic Airbox nog groter. De Carbon Dynamic Airbox zorgt niet alleen voor extra vermogen en koppel maar ook voor een directer gasrespons en een soepeler verloop. Bij een zelfde rijstijl als voorheen is het zelfs zo dat de auto zuiniger wordt... Dit is mede te danken aan een betere lucht/mengsel verhouding, vullingsgraad en dus een betere verbranding. Het resultaat is meer vermogen over het gehele gebied, waardoor het gaspedaal minder diep ingetrapt hoeft te worden om hetzelfde vermogen te krijgen en er dus een klein beetje minder brandstof wordt ingespoten.

Omdat het aanzuigpunt van de filter laag zit door de air intake slang hoort u in de auto iets minder van het aanzuigen als dat van een normale openluchtfILTER. Echter is het buiten de auto ronduit spectaculair! Maar deze filters zijn niet ontworpen om geluid te produceren maar om echte vermogenswinst te creëren. Dit zelfde systeem gebruikt BMC o.a. ook in de Formule-1 en de 24h races (5 bekende Formule-1 teams met o.a. het Ferrari team racen ook met BMC). Met een BMC Carbon Dynamic Airbox hebt u alvast één ding gemeen met 's werelds beste coureurs...



Zoals de naam al doet vermoeden is de Carbon Dynamic Airbox rijkelijk uitgerust in 100% gevlochten Carbon. Dit geeft de airbox niet alleen een exotisch uiterlijk maar heeft ook als voordeel dat deze airbox ultralicht is en de motorwarmte buiten de box houdt (Carbon is namelijk een perfecte isolator).

U kunt een Carbon Dynamic Airbox met geen enkel ander luchtsysteem vergelijken, het is een uniek systeem waar patent op zit. Met een CDA box hebt u iets unieks en sensationeels in uw auto zitten en het zal uw wensen doen overtreffen.

BMC... 's Werelds beste luchtfILTER merk!

Carbon Dynamic Airbox



Speciale CDA (Carbon Dynamic Airbox) Kits

Bestelnr	Aansluitdiam.	Buitendiam.	Lengte
CDA SP-01	80	150	200
CDA SP-02	80	150	260
CDA SP-03	92	150	260
CDA SP-04	100	150	470
CDA SP-11	81	150	200

De CDA SP-11 is speciaal ontwikkeld voor de Nissan 350 Z

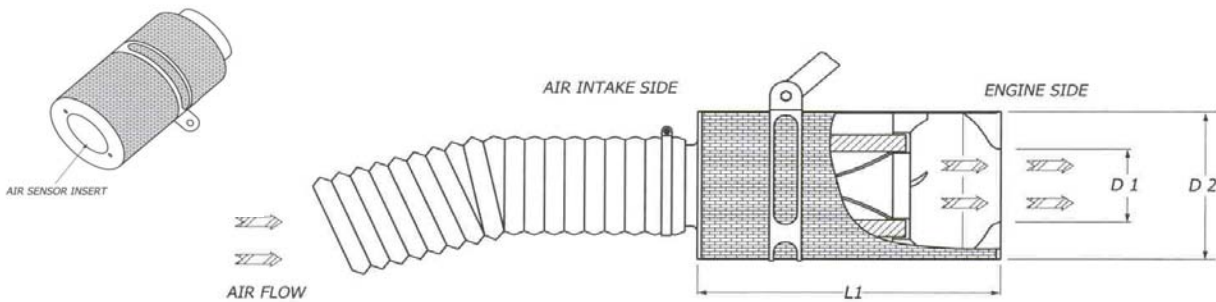

Geadviseerde applicatie voor auto's met een BOSCH luchtmassa meter met een diameter van 80mm (CDA SP-01, CDA SP-02) en een diameter van 90 mm (CDA SP-03). De luchtmassa meter moet direct gemonteerd worden op de motor zijde van de CDA.

Speciale CDA (Carbon Dynamic Airbox) Kits

Bestelnr	Aansluitdiam.	Buitendiam.	Lengte
CDA SP-06	100	186	236
CDA SP-07	85	150	160
CDA SP-08	70	150	160
CDA SP-10	70	150	200

De CDA SP-06 is speciaal ontwikkeld voor de BMW M3 E46

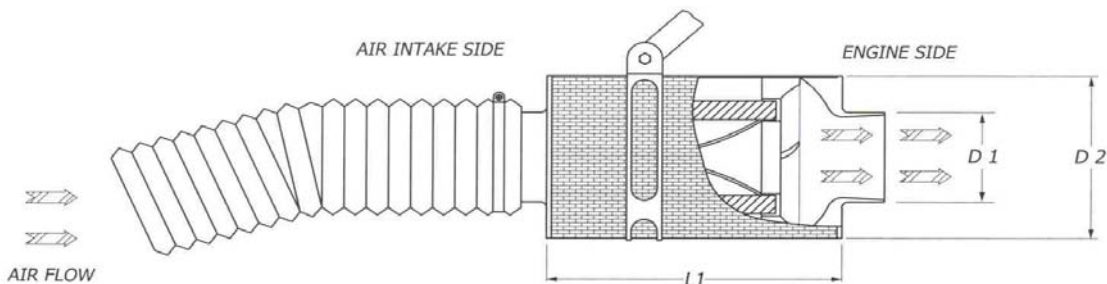

Carbon Dynamic Airbox

Speciale CDA (Carbon Dynamic Airbox) Kits

Bestelnr	Aansluitdiam.	Buitendiam.	Lengte
CDA SP-05	70	150	200
CDA SP-09	80	150	200
CDA SP-12	80	150	260
CDA SP-14			

Binnenkort

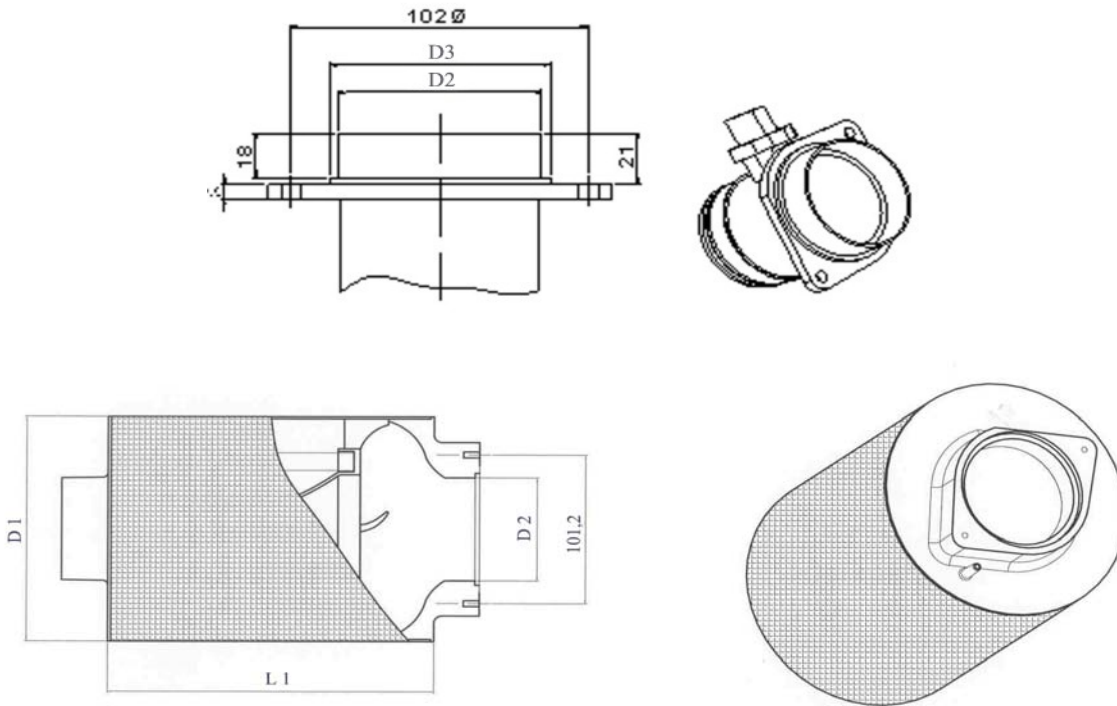

De CDA SP-05, CDA SP-09 en CDA SP-12 - Carbon Dynamic Airbox - Kan alleen geïnstalleerd worden op auto's die een originele BOSCH Luchtmassa meter >PBT-GF30< (Ø 70mm en Ø 80mm) hebben. Zie hiervoor de bovenstaande tekeningen. Dankzij een speciale adapter op de CDA is het mogelijk om de de Luchtmassa meter direct op de filter te monteren. Dit garandeert een zeer gemakkelijke aansluiting tussen de twee componenten, reduceert een zeer groot gedeelte van de in te nemen ruimte en zorgt ervoor dat er een betere lucht doorvoer mogelijk is.

CDA (Carbon Dynamic Airbox) - Universeel

Bestelnr	Aansluitdiam.	Buitendiam.	Lengte
CDA 60-130 (>> - 1600cc)	60	130	185
CDA 65-130 (>> - 1600cc)	65	130	185
CDA 70-130 (>> - 1600cc)	70	130	185
CDA 70-130WC (o.a. watersport)	70	130	130
CDA 70-150 (1600cc - >>)	70	150	200
CDA 85-150 (1600cc - >>)	85	150	200

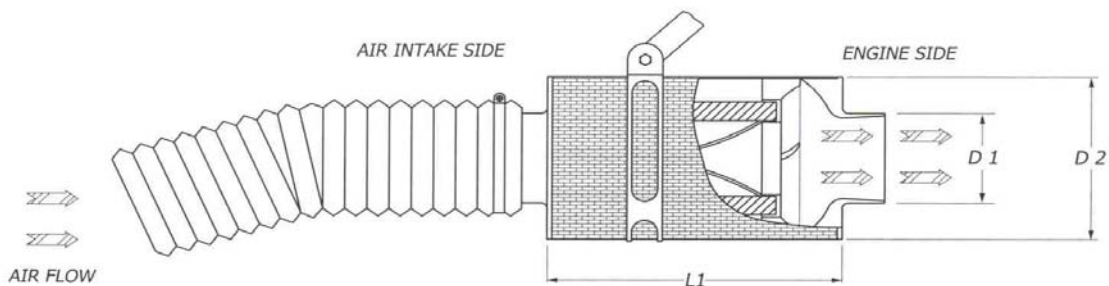

Carbon Dynamic Airbox Applicaties

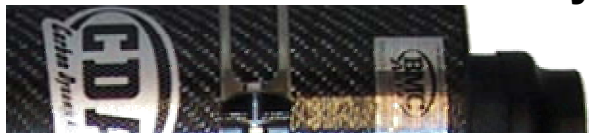

Andere modellen op aanvraag



	Foto	CDA	ACCESSOIRES (Niet Inbegrepen)
--	------	-----	-------------------------------

Alfa Romeo

145	1.3 Boxer	1A	CDA 70-130	
	1.6 TS 16V	1B	CDA 70-130	
147	1.6 TS 16V	1E	CDA 70-130	
	1.9 JTD		CDA 70-130	SAC 09070
	2.0 TS 16V	1F	CDA 70-150	SATR 60070
	2.0 TS Selespeed	1H	CDA 70-150	
	3.2 V6 GTA	1G	CDA SP-01	Flens aanpassen tot 87mm
155			CDA 70-130	
156	1.6 TS 16V	1D	CDA 70-150	SAM 08070, SAC 09070, SPV 10070
	1.8 TS 16V	1D	CDA 70-150	SAM 08070, SAC 09070, SPV 10070
	1.9 JTD	1C	CDA 70-150	SAM 08070
	2.0 TS 16V		CDA 70-150	SAM 08070
	2.4 JTD		CDA 70-150	SAM 08070, SAC 09070, SPV 10070
	3.2 V6 GTA		CDA SP-01	Flens aanpassen tot 87mm
166	2.0 TS 16V		CDA 85-150	
	2.4 JTD		CDA 70-150	SAM 08070, SAC 09070
GTV	3.0 24V		CDA 70-150	SAC 09070

Audi

80 / 90	2.8 V6		CDA 85-150	
S2	2.2 Turbo		CDA SP-01	
A3	1.8		CDA 70-150	SAM 08070, SA 16-40
	1.8 Turbo	2A	CDA 70-150	SAM 08070, SA 16-40
	1.9 TDI 90pk	2B	CDA 70-150	SAM 08070, SA 16-40
	1.9 TDI 110pk		CDA 70-150	SAM 08070, SA 16-40
	1.9 TDI 130pk		CDA 85-150	SAM 08085
	2.0 TDI 140pk	2I	CDA SP-09	SPV 10080, SAM 08085
	S3	1.8 Turbo Quattro	2C	CDA SP-02
A4	1.8		CDA SP-01	
	1.8 Turbo		CDA SP-01	
	1.9 TDI		CDA SP-05	
	2.5 TDI V6		CDA SP-01	
	2.5 TDI V6 Serie 2	2H	CDA 85-150	SAM 08085
	3.0 V6 Serie 2		CDA 85-150	Flens aanpassen tot 80mm
S4	2.2 Turbo 20V		CDA 85-150	
	2.7 Biturbo		CDA SP-02	
RS4	2.7 BiTurbo	2D	CDA SP-03	excl. adaptor voor originele lucht inlaat
A6	2.5 TDI V6	2E	CDA SP-01	excl. adaptor voor originele lucht inlaat
TT	1.8 T 180pk	2G	CDA SP-05	
	1.8 T Quattro 225pk	2F	CDA SP-12	
	3.2 250pk		CDA SP-12	

BMW

3 Serie	316 i (E36)		CDA SP-05	
	318 is (E30)		CDA 65-130	
	318 is (E36)		CDA 70-150	
	318 Ci (E46)		CDA 70-150	SAM 08070
	320 i (E36)		CDA 70-150	SAM 08070, SA 16-40
	320 i (E46)	3I	CDA 85-150	SAM 08085
	323 Ci (E46)		CDA 85-150	SAM 08085
	325 i (E30)		CDA 85-150	Flens aanpassen
	325 TI Compact (E46)		CDA 85-150	SAM 08085
	328 i (E36)	3M	CDA 85-150	SAM 08085

Carbon Dynamic Airbox Applicaties

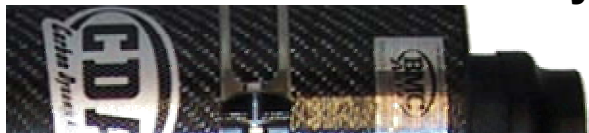

Andere modellen op aanvraag



	Foto	CDA	ACCESSOIRES (Niet Inbegrepen)
--	------	-----	-------------------------------

BMW Vervolg

3 Serie	328 i (E46)	3B	CDA 85-150	SAM 08085
	330 Ci (E46)	3P	CDA 85-150	SAM 08085
	M3 4 Cil. (E30)		CDA 85-150	Flens aanpassen
	M3 3.0 (E36)	3A	CDA 85-150	SA 20-40, flens aanpassen tot 80mm
	M3 3.2 (E36)	3H	CDA 85-150	SA 20-40, SAM 08085
	M3 3.2 (E46)	3O	CDA SP-06	
5 Serie	528 (E39)		CDA 85-150	SAM 08085
	M5 5.0 i (E39)	3C	2 x CDA 85-150	
7 Serie	750 il	3Q	2 x CDA 70-150	2 x SAM 08070
X-5	3.0 i	3G	CDA SP-01	
Z1	Alle modellen	3D	CDA 70-150	SAD 708233, SAM 08070
Z3	1.8 i	3E	CDA 70-130	SAM 08070, SA 16-40
	1.9 i		CDA 70-150	SAC 09070
	2.8 i	3N	CDA SP-07	SAM 08085
	3.0 i	3F	CDA SP-07	SAM 08085
Z4	3.0 i	3L	CDA SP-02	

Chrysler

PT Cruiser	2.0 16V	23A	CDA 60-130	
	2.2 CRD	23B	CDA SP-05	

Citroën

C3	1.6 16V	4E	CDA 70-130	SAC 09070, SA 12-40
Saxo	1.4 8V		CDA 70-130	SAC 09070
	1.6 VTS 8V	4A	CDA 70-130	2 x SA 20-40
	1.6 VTS 16V	4B	CDA 70-130	SA 12-40
Xsara	1.4 VTR	4D	CDA 70-130	SATR 60070
	1.9 D		CDA 70-150	SATR 60070
	2.0 16V		CDA 70-150	SATR 60070
	2.0 HDI 90pk		CDA 70-150	SAM 08070, SAC 09070, SPV 10070
Xsara Picasso	1.8 16V	4C	CDA 65-130	

Ferrari

348		5A	2 x CDA 85-150	
355		5B	2 x CDA 85-150	
360 Modena		5C	2 x CDA 85-150	excl. adaptor voor originele lucht inlaat

Fiat

Barchetta	1.8 16V	6G	CDA 70-150	
Bravo	1.6 16V	6H	CDA 70-130	SAM 08070
	1.8 16V		CDA 70-150	SATR 60070
	2.0 20V HGT	6F	CDA 70-150	SATR 60070
Coupé	2.0 20V	6L	CDA 70-150	SATR 60070
Punto	1.2 8V	6B	CDA 70-130	SAC 09070, SARI 001
	1.2 16V Sporting	6C	CDA 60-130	SAM 08060
	1.4 GT	6D	CDA 70-130	SAC 09070, SPV 10070, SAM 08070
	1.8 16V HGT	6E	CDA 70-150	SAC 09070
	1.9 JTD	6M	CDA 70-150	SAC 09070
Seicento (600)	1.1 Sporting	6A	CDA 70-130	SA 16-40, excl. adaptor voor mono inj.
Stilo	1.6 16V		CDA 70-150	

Carbon Dynamic Airbox Applicaties

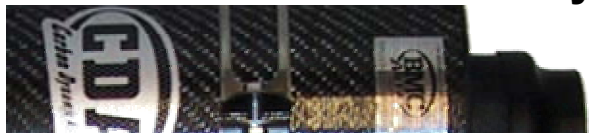

Andere modellen op aanvraag



	Foto	CDA	ACCESSOIRES (Niet Inbegrepen)
	2.4 20V Abarth	6I	CDA SP-05

Ford			
Escort	Cosworth 2.0 16V T	27C	CDA 70-150
Fiesta	1.4 16V (Serie III)	27D	CDA 70-150
	Zetec SE		CDA 70-130
Focus	1.8 16V	27B	CDA 70-150
Ka	1.3		CDA 70-130
Mondeo	2.0 TdCi 115pk		CDA 70-150
	2.0 TdCi 130pk		CDA 70-150
Probe	2.5	27A	CDA 85-150
Puma	1.4 16V		CDA 70-130
			SAC 09070

Honda			
Civic	1.4	7A	CDA 70-130
	1.5 8V '97>	7G	CDA 70-130
	1.6 VTEC	7B	CDA 70-130
	1.7 CTDI	7H	CDA SP-08
	2.0 VTEC Type-R	7F	CDA 85-150
Integra	Type R	7C	CDA 85-150
Prelude	2.0 16V		CDA 85-150
	2.2 VTEC 4WS	7D	CDA 70-150
S2000	2.0	7E	CDA SP-04

Hyundai			
Coupé	1.6 16V	29A	CDA 70-150
	2.7 V6		CDA 85-150

Jaguar			
XJR	4.0	26A	CDA 85-150
			SAM 08085

Jeep			
Grand Cherokee	2.7 CRD	25A	CDA 85-150
			SAM 08085

Lamborghini			
Countach	4 kleppen	28A	2 x CDA 85-150
Diablo	2 WD	28B	2 x CDA 85-150
			Excl. flexibele slangen
			Excl. flexibele slangen

Lancia			
Delta	1.6 16v HPE	8C	CDA 70-130
Thema	Turbo i.e. 16V	8B	CDA 85-150
Ypsilon	1.2 16V	8A	CDA 70-130
			SAM 08070, SA 16-40

Land Rover			
Discovery	2.5 TD		CDA 70-150

Lotus			
Elise	1.8	9A	CDA 70-150

Mazda			
MX-6	2.5		CDA 85-150

Carbon Dynamic Airbox Applicaties

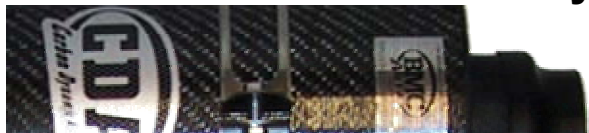

Andere modellen op aanvraag



Foto	CDA	ACCESSOIRES (Niet Inbegrepen)
------	-----	-------------------------------

Mercedes

A-Klasse	140	10A	CDA 70-130	
CL-Klasse	CL 55 AMG	10B	2 x CDA 85-150	
E-Klasse	200		CDA 70-150	
	300 D		CDA 70-150	
M-Klasse	ML 270 CDI	10C	CDA 85-150	
	ML 320 (V6)		CDA 85-150	
	ML 400 CDI (V8)	10E	CDA 85-150	SAM 08085
SLK-Klasse	230 Kompressor		CDA 70-150	
	260		CDA 70-150	
	320		CDA 70-150	
V-Klasse	220 CDI	10D	CDA 70-150	SAC 09070
Vito	112 CDI	10F	CDA 70-150	

MG

ZR	105	32A	CDA 60-130	
	160	32B	CDA 70-150	SAC 09070
ZS	180	32C	CDA 70-150	SAC09070, SPV10070 (verkorten tot 30mm)

Mini

Mini	1.6 One	22A	CDA 70-130	
	Cooper S	22B	CDA SP-10	

Mitsubishi

Galant	2.5 V6 EA5		CDA 85-150	Past met speciale flens
L 200	2.5 TDI GLS	11B	CDA 70-150	
Lancer	2.0 EVO VI	11A	CDA 85-150	Flens aanpassen

Nissan

100 NX	2.0 16V		CDA 85-150	Flens aanpassen
200 SX	1.8		CDA 85-150	Flens aanpassen
350 Z	3.5 V6	12B	CDA SP-11	
Almera	2.2 DTI	12A	CDA 85-150	Flens aanpassen tot 80mm
Patrol	GR 4.2		CDA 85-150	SATR 60082

Opel

Astra	1.4		CDA 60-130	
	1.6 16V		CDA 70-150	
	2.0 Dti	13B	CDA 70-150	SAC 09070
	2.0 16V Turbo	13E	CDA 70-150	
	2.0 16V OPC	13F	CDA 70-150	SAC 09070
	2.2 16V	13N	CDA 85-150	
Calibra	2.0 8V		CDA 85-150	Flens aanpassen
Corsa	1.0 12V	13M	CDA 60-130	
	1.2 8V		CDA 60-130	SATR 60060
	1.4		CDA 60-130	
	1.6 16V		CDA 60-130	
	1.7 Dti	13I	CDA 70-130	SAM 08070
	1.6 GSI 16V		CDA 85-150	SAM 08085
	1.8 GSI 16V		CDA 70-150	SATR 60070
Omega	2.5 TD	13L	CDA SP-07	
Speedster	2.2 16V	13H	CDA 70-150	SAM 08070

Carbon Dynamic Airbox Applicaties

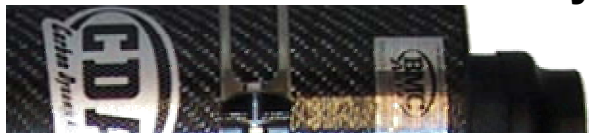

Andere modellen op aanvraag



		Foto	CDA	ACCESSOIRES (Niet Inbegrepen)
--	--	------	-----	-------------------------------

Tigra	1.4	13A	CDA 60-130	
Opel Vervolg				
Tigra	1.6 16V	13A	CDA 60-130	
Vectra	1.8 CDX	13D	CDA 70-150	
	2.0 CDI		CDA 70-150	
	2.0 DTI 16V	13C	CDA 70-150	
Zafira	1.8 16V	13G	CDA 70-150	SAC 09070
	2.2 DTI		CDA 70-150	SARI 002

Peugeot

106	1.4 Sport	14A	CDA 60-130	SATR 60060, SA 12-40
	GTI 16V	14B	CDA 70-130	
	1.6 XS 16V	14C	CDA 70-130	SA 12-40
	Rally 8V	14L	CDA 60-130	
205	GTI 1.6	14M	CDA 70-130	
	GTI 1.9		CDA 70-130	
206	1.4		CDA 60-130	SATR 60070, SA 16-40
	1.6		CDA 70-150	SATR 60070, 2 x SA 20-40
	1.6 XS 16V	14D	CDA 70-150	SATR 60070
	1.6 XS 16V 110pk		CDA 70-130	SAC 09070, SPV 10070
	2.0 Hdi		CDA 70-150	SAM 08070
	2.0 16V		CDA 70-150	SATR 60070
	2.0 16V RC	14O	CDA 70-130	SAC 09070
	2.0 GTi	14E	CDA 70-150	SAC 09070
306	1.6		CDA 70-150	SATR 60070, 2 x SA 20-40
	1.8 16V		CDA 70-150	
	2.0 HDi		CDA 70-130	
307	1.6 16V	14H	CDA 65-130	SARI 001
	2.0 16V		CDA 70-150	
	2.0 HDI 90pk	14G	CDA 70-150	SAC 09070
	2.0 HDI 110pk		CDA 70-150	SAC 09070
	2.0 HDI 16V 136pk		CDA 70-150	SAC 09070
309	2.0 GTI 16V		CDA 70-130	
405	1.9 16V		CDA 70-150	SAM 08070
	2.0 MI 16V		CDA 70-150	SATR 60070
	T 16V		CDA 70-130	2 x SA16-40, SA 20-40
406 / 406 Coupé	2.0 HDI		CDA 70-150	SATR 60070
	2.2 HDI	14I	CDA 85-150	
	3.0 V6 24V	14F	CDA 85-150	SA 12-40, SA 16-40

Porsche

944		15B	CDA 85-150 met flens adaptor	
993			CDA 85-150	excl. rubber adaptor
996		15A	CDA 85-150	

Renault

R 5	GT Turbo		CDA 60-130	
R 19	1.9 TD		CDA 70-130	SAC 09070
R 21	2.0 Turbo		CDA 85-150	
R 25	2.5 V6 Turbo		CDA 70-130	SA 16-40
Alpine	V6 Turbo		CDA 70-150	SAM 08070
Avantime	3.0 V6		CDA 85-150	
Clio	1.4 S	16A	CDA 60-130	SATR 60060
	1.6 16V		CDA 70-130	Flens aanpassen

Carbon Dynamic Airbox Applicaties

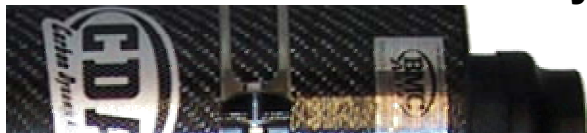

Andere modellen op aanvraag



		Foto	CDA	ACCESSOIRES (Niet Inbegrepen)
	1.8 16V	16G	CDA SP-08	SAC 09070, excl. ovale flens adaptor
Renault Vervolg				
Clio	2.0 16V 172pk		CDA SP-08	
	RS 2000 16V	16B	CDA 70-150	
	RS 2000L 16V (01->)	16F	CDA SP-08	
	Williams 2.0		CDA SP-07	Speciale flens (AAPK003)
	3.0 V6 24V Sport	16L	CDA 85-150	
Laguna	1.6 16V	16E	CDA 70-130	
	1.9 DCI 110pk	16H	CDA 70-130	SAM 08070, SPV 10070, SAC 09070
	1.9 DCI 120pk	16H	CDA 70-130	SAM 08070, SPV 10070, SAC 09070
Master	2.8 TDI	16I	CDA 70-150	
Megane	1.6 16V		CDA 70-130	SAC 09070
	1.9 DTI	16C	CDA 70-150	SAM 08070
	2.0 16V		CDA 70-150	
	2.0 16V IDE		CDA 85-150	SAM 08085
	Coupé 2.0 16V		CDA 70-150	SAC 09070
Megane II	1.6 16V	16N	CDA 70-130	SAC 09070
Scenic	1.6 16V	16D	CDA 70-130	
	1.9 DTI		CDA 70-150	SATR 60070
	RX4 DCI	16M	CDA 70-150	SATR 60070

Rover				
25	1.6 16V		CDA 70-130	
600	620 TI	17A	CDA 70-150	SAC 09070

Saab				
900	2.0 i Turbo Aero	30A	CDA 70-150	SAC 09070, SPV 10070

Seat				
Arosa	1.4 Tdi		CDA 70-130	SAC 09070
Cordoba	2.0 16V		CDA 70-150	SA 16-40
Ibiza	1.4 16V	18A	CDA 70-130	SAC 09070, SA 16-40
	1.4 16V 02>	18E	CDA 70-130	SAC 09070
	1.8 Turbo 20V	18C	CDA 85-150	SAM 08085
	1.8 T Cupra		CDA SP-02	
	1.9 TDI 110pk		CDA SP-05	
	1.9 TDI 130pk		CDA SP-09	
Leon	1.9 TDI 110pk	18B	CDA 70-150	SAM 08070
	1.9 TDI Cupra 150pk	18D	CDA 85-150	SAM 08085
	1.8 Turbo 20V 180pk		CDA SP-01	
	1.8 T 20V Cupra 225pk		CDA SP-02	
Toledo	TDI 110pk		CDA 70-150	SAD 708233, SAM 08070

Smart				
	??	19A	??	??

Subaru				
Impreza	GT 211pk	24A	CDA 85-150	SA 12-40, Flens aanpassen
	GT 215pk		CDA 85-150	Flens aanpassen
	GT 215pk ABS		CDA 85-150	Flens aanpassen
	GT 217pk		CDA 85-150	Flens aanpassen
	GT 217pk ABS	24B	CDA 85-150	Flens aanpassen
	WRX 218pk		CDA 85-150	Flens aanpassen

Carbon Dynamic Airbox Applicaties

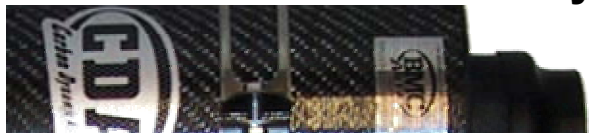

Andere modellen op aanvraag



Foto	CDA	ACCESSOIRES (Niet Inbegrepen)
------	-----	-------------------------------

Toyota

Celica	T20	20A	CDA 70-150	
	1.8 VVTI	20C	CDA 70-150	SAC 09070
Hi Lux	2.8		CDA 70-150	
MR2	1.8 VVTI		CDA 70-150	
	2.0	20E	CDA 70-130	SARI 001, Orig. buiswerk gebruiken
	2.0 Turbo	20B	CDA 70-150	
Paseo	1.5		CDA 60-130	SATR 60060
Picnic	2.0 16V		CDA 65-130	
Yaris	1.0 VVT-i	20D	CDA 70-130	SAC 09070, SARI 002, SATR 60060

Volkswagen

Bora	1.6	21I	CDA 70-150	SAC 09070
	1.8 GTI	21H	CDA SP-05	
	TDI 90pk	21C	CDA 70-150	SA 16-40, SAM 08070
	TDI 110pk	21C	CDA 70-150	SA 16-40, SAM 08070
	TDI 115pk	21E	CDA 70-150	SAM 08070
	TDI 130pk		CDA SP-09	
	TDI GTI 150pk	21F	CDA SP-02	SA 16-40
	2.8 I VR6	21G	CDA 85-150	SAM 08085
Golf II	1.8 GTI 8V		CDA 70-130	SAD 708233, SAM 08070
Golf III	1.8 GTI	21B	CDA 70-130	SAD 708233, SAM 08070, SATR 60070
	1.8 Spi		CDA 70-150	SAC 09070, SATR 60082, SPV 10080
	2.8 I VR6		CDA 85-150	
	TDI 110pk		CDA 70-150	SAD 708233, SAM 08070
Golf IV	1.6	21I	CDA 70-150	SAC 09070
	1.8 GTI	21H	CDA SP-05	
	TDI 90pk	21C	CDA 70-150	SA 16-40, SAM 08070
	TDI 110pk	21C	CDA 70-150	SA 16-40, SAM 08070
	TDI 115pk	21E	CDA 70-150	SAM 08070
	TDI 130pk		CDA SP-09	
	TDI GTI 150pk	21F	CDA SP-02	SA 16-40
	2.8 I VR6	21G	CDA 85-150	SAM 08085
	R32	21L	CDA SP-12	
Golf V	2.0 T FSI GTI	21O	CDA SP-14	Binnenkort leverbaar
	2.0 TDI 140pk	21N	CDA SP-09	SPV 10080, SAM 08085
Jetta	1.8 GTI 8V		CDA 70-130	SAD 708233, SAM 08070
Lupo	1.4		CDA 65-130	
	1.6 GTI	21D	CDA 70-130	SAC 09070
Passat	2.8 I VR6		CDA 85-150	
	TDI 90pk		CDA SP-09	
Polo	1.1	21M	CDA 70-130	SAC 09070
	1.4		CDA 70-130	
	1.4 16V	21A	CDA 70-130	SAC 09070, SA 16-40
Vento	1.8 GTI	21B	CDA 70-130	SAD 708233, SAM 08070, SATR 60070
	2.8 I VR6		CDA 85-150	
	TDI 110pk		CDA 70-150	SAD 708233, SAM 08070

Volvo

850	2.3i Turbo 20V T5		CDA SP-05	
S 40	2.0 16V Turbo	31A	CDA SP-01	
	T4		CDA SP-01	
V 40	2.0 16V Turbo	31A	CDA SP-01	

Carbon Dynamic Airbox Applicaties

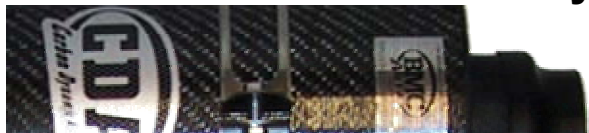

Andere modellen op aanvraag

		Foto	CDA	ACCESSOIRES (Niet Inbegrepen)
	T4		CDA SP-01	
S 60	2.3 Turbo V5	31C	CDA SP-09	
	2.4 Turbo		CDA SP-09	
	2.5 Turbo T5	31B	CDA SP-09	
S 70	2.3 Turbo V5	31C	CDA SP-09	
Volvo Vervolg				
S 70	2.5 Turbo T5	31B	CDA SP-09	
V 70	2.3 Turbo V5	31C	CDA SP-09	
	2.5 Turbo T5	31B	CDA SP-09	
C 70	2.3 Turbo V5	31C	CDA SP-09	
	2.5 Turbo T5	31B	CDA SP-09	
S 80	2.8 Turbo T6	31D	CDA SP-02	Flens aanpassen tot 86mm

Accessoires

Luchtfilter olie en reiniger



Omschrijving	Inhoud	Bestelnr
Luchtfilter olie	250ml	WA OIL250
Luchtfilter olie, spray	200ml	WA OIL200
Luchtfilter reiniger	355ml	WA DET355
Luchtfilter olie en reiniger set		WA 250/355
Luchtfilter olie (spray) en reiniger set		WA 200/355

CDA - interne filter element

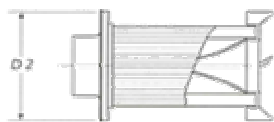
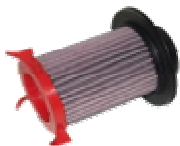

Diameter	Bestelnr
130	CDA RI-130
150	CDA RI-150

Siliconen Connector Buis (dikte 5mm)

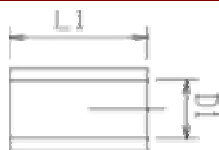

Diameter 1	Lengte 1	Bestelnr
60	80	SAM 08060
70	80	SAM 08070
85	80	SAM 08085

EPDM Rubber Connector met een bocht van 90° (dikte 5mm)

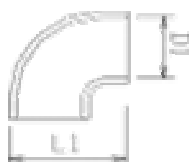

Diameter	Lengte	Bestelnr
70	110	SAC 09070

Roestvrijstalen Klem met Rubberen Inleg

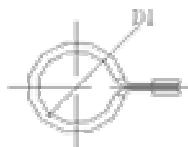

Diameter	Bestelnr
80	SAF 00080

Flexibele Aluminium Buis



Diameter	Lengte	Bestelnr
60	500	SAT 50060
70	500	SAT 50070
80	500	SAT 50080
60	600	SATR 60060
70	600	SATR 60070
82	600	SATR 60082

Roodgeverfde Stalen Connector met Pin voor Ophanging (dikte 1,5mm)



Diameter	Lengte	Bestelnr
60	100	SPV 10060
70	100	SPV 10070
80	100	SPV 10080

Accessoires

Nylon Adapters

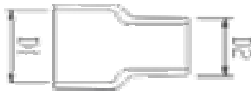

Diameter 1	Diameter 2	Bestelnr
70	60	SARI 001
70	65	SARI 002
85	70	SARI 003

Ophangbeugel



Lengte	Bestelnr
200	SPF 200

Luchtmasa Sensor Connector (vierkante flens)

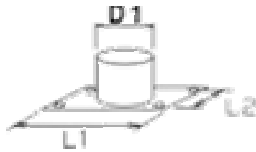

Diameter	Lengte 1/2	Bestelnr
70	82 / 33	SAD 708233

Carter Ontluchting - Universeel



Diameter	Lengte 1/2	Bestelnr
12	40	SA 12-40
16	40	SA 16-40
20	40	SA 20-40
25	40	SA 25-40

Luchtfiler Display

Bestelnr

Bel voor info!



Type "Auto"

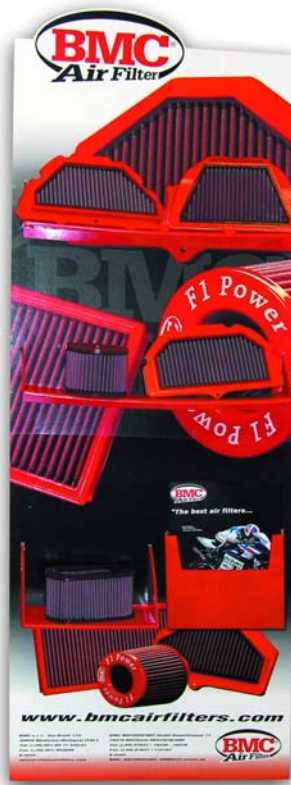

Type "Motor"