

Race Openlucht Filters

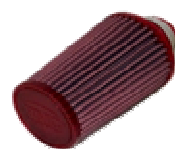

Conische Simple Air - Universeel

	Bestelnr	Aansluitdiam.	Buitendiam.	Lengte
<p>Tot 1600cc</p>	SA 60-150	60	115	150
	SA 65-150	65	115	150
	SA 70-150	70	115	150
<p>Tot 1600cc</p>	SS 50-150	50	115	150
	SS 60-150	60	115	150
	SS 70-150	70	115	150
<p>Tot 1600cc</p>	SA 60-128	60	115	128
	SA 65-128	65	115	128
	SA 70-128	70	115	128
<p>Tot 1600cc</p>	SS 50-128	50	115	128
	SS 60-128	60	115	128
	SS 70-128	70	115	128
<p>Boven 1600cc</p>	SA 60-140	60	150	140
	SA 70-140	70	150	140
	SA 80-140	80	150	140
	SA 85-140	85	150	140
	SA 100-140	100	150	140
	SA 110-140	110	150	140
<p>Boven 1600cc</p>	SA 60-110	60	150	110
	SA 70-110	70	150	110
	SA 80-110	80	150	110
	SA 100-110	100	150	110

Carter Ontluchting - Universeel

	Bestelnr	Aansluitdiam.	Lengte
	SA 12-40	12	40
	SA 16-40	16	40
	SA 20-40	20	40
	SA 25-40	25	40



Race Openlucht Filters

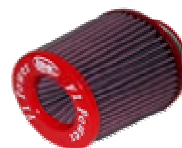

Conische Twin Air - Universeel met plastic bovenkant (rood)

	Bestelnr	Aansluitdiam.	Buitendiam.	Lengte
	TW 60-150P	60	115	150
	TW 65-150P	65	115	150
	TW 70-150P	70	115	150
	TS 50-150P	50	115	150
	TS 60-150P	60	115	150
	TS 70-150P	70	115	150
	TW 60-140P	60	150	140
	TW 70-140P	70	150	140
	TW 80-140P	80	150	140
	TW 85-140P	85	150	140
	TW 90-140P	90	150	140
	TW 100-140P	100	150	140
	TW 110-140P	110	150	140
	TW 130-140P	130	150	140
	TW 150-140P	150	150	140
	TW 90-130P	90	150	130
(Aanbevolen voor Porsche applicaties met Bosch sensor)				

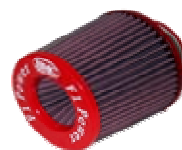

Conische Twin Air - Universeel met lichtmetalen bovenkant (rood gespoten)

	Bestelnr	Aansluitdiam.	Buitendiam.	Lengte
	TW 60-150	60	115	150
	TW 65-150	65	115	150
	TW 70-150	70	115	150
	TS 50-150	50	115	150
	TS 60-150	60	115	150
	TS 70-150	70	115	150
	TW 60-140	60	150	140
	TW 70-140	70	150	140
	TW 80-140	80	150	140
	TW 85-140	85	150	140
	TW 90-140	90	150	140
	TW 100-140	100	150	140
	TW 110-140	110	150	140
	TW 130-140	130	150	140
	TW 150-140	150	150	140
	TW 90-130	90	150	130
(Aanbevolen voor Porsche applicaties met Bosch sensor)				

Race Openlucht Filters

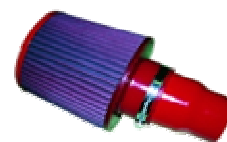

VAS (Venturi Admission System) - Universeel

Bestelnr	Diameter 1	Diameter 2	Buitendiam.	Lengte
VAS 60-80	60	80	150	140
VAS 70-80	70	80	150	140

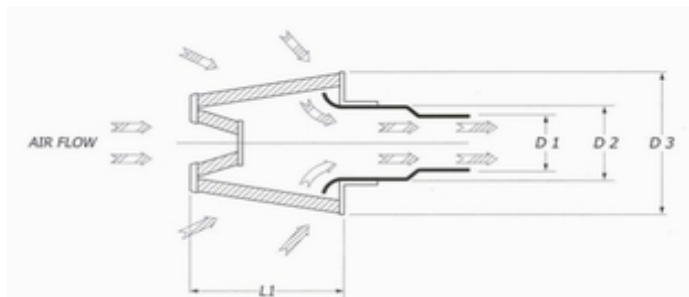

DIA (Direct Intake Airsystem) - Universeel

Bestelnr	Diameter 1	Diameter 2	Buitendiam.	Lengte
DIA 70-130	70/65/60	130	idem	140

Geleverd inclusief flexibele zwarte aanzuigbuis en verschillende nylon adapters, zodat de DIA 70-130 op 70, 65 en 60 mm aansluitingen past.

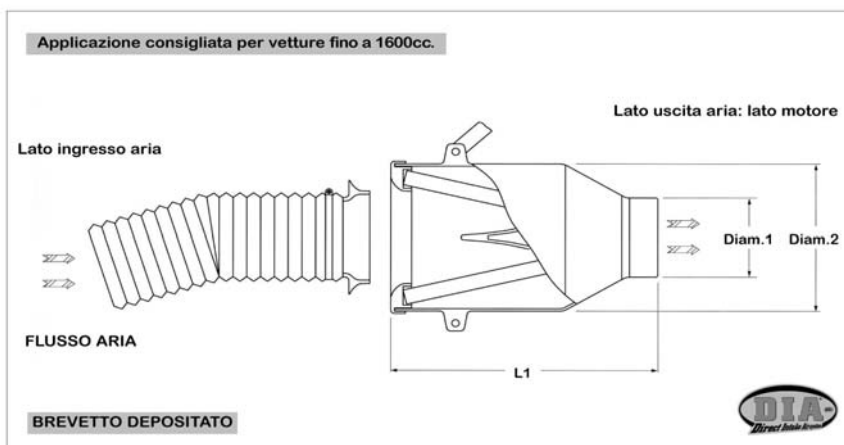

Zie Carbon Dynamic Airbox voor uitleg werkingsprincipe



*Patented
Supercharging System*

Accessoires

Luchtfilter olie en reiniger



Omschrijving	Inhoud	Bestelnr
Luchtfilter olie	250ml	WA OIL250
Luchtfilter olie, spray	200ml	WA OIL200
Luchtfilter reiniger	355ml	WA DET355
Luchtfilter olie en reiniger set		WA 250/355
Luchtfilter olie (spray) en reiniger set		WA 200/355

CDA - interne filter element

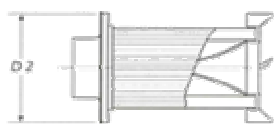
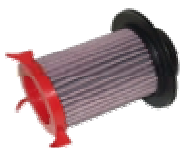

Diameter	Bestelnr
130	CDA RI-130
150	CDA RI-150

Siliconen Connector Buis (dikte 5mm)

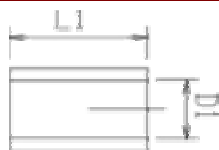

Diameter 1	Lengte 1	Bestelnr
60	80	SAM 08060
70	80	SAM 08070
85	80	SAM 08085

EPDM Rubber Connector met een bocht van 90° (dikte 5mm)

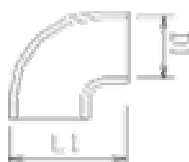

Diameter	Lengte	Bestelnr
70	110	SAC 09070

Roestvrijstalen Klem met Rubberen Inleg

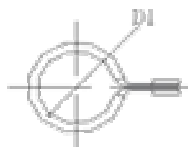

Diameter	Bestelnr
80	SAF 00080

Flexibele Aluminium Buis

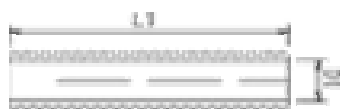

Diameter	Lengte	Bestelnr
60	500	SAT 50060
70	500	SAT 50070
80	500	SAT 50080
60	600	SATR 60060
70	600	SATR 60070
82	600	SATR 60082

Roodgeverfde Stalen Connector met Pin voor Ophanging (dikte 1,5mm)



Diameter	Lengte	Bestelnr
60	100	SPV 10060
70	100	SPV 10070
80	100	SPV 10080

Accessoires

Nylon Adapters

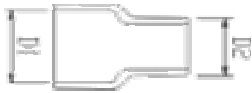

Diameter 1	Diameter 2	Bestelnr
70	60	SARI 001
70	65	SARI 002
85	70	SARI 003

Ophangbeugel



Lengte	Bestelnr
200	SPF 200

Luchtmasa Sensor Connector (vierkante flens)

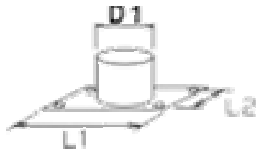

Diameter	Lengte 1/2	Bestelnr
70	82 / 33	SAD 708233

Carter Ontluchting - Universeel



Diameter	Lengte 1/2	Bestelnr
12	40	SA 12-40
16	40	SA 16-40
20	40	SA 20-40
25	40	SA 25-40

Luchtfiler Display

Bestelnr

Bel voor info!



Type "Auto"

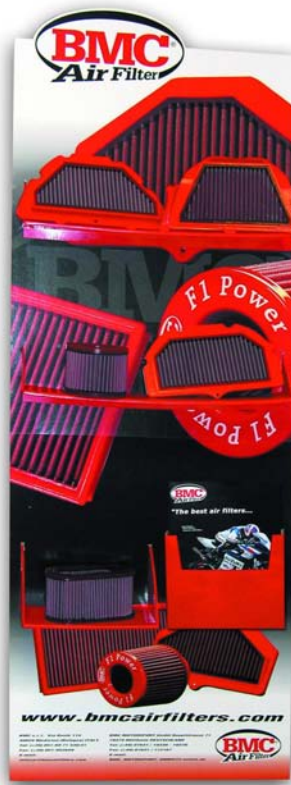

Type "Motor"